



KP2100-POWER THYRISTOR

6000-6500 V_{DRM}

FREE FLOATING TYPE THYRISTOR FOR PHASE CONTROL APPLICATIONS

Features:

- . Free-floating silicon technology
- . Low on-state and switching losses
- . Optimum power handling capability
- . Blocking capability up to 6500 volts
- . Distributed amplifying gate

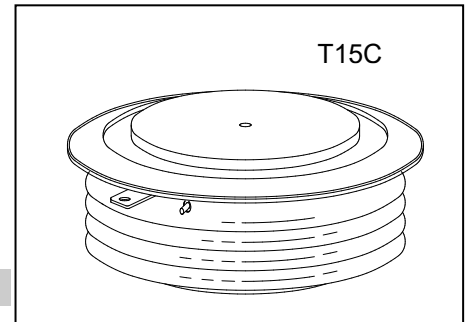

ELECTRICAL CHARACTERISTICS AND RATINGS

Blocking - Off State

Device Type	V_{RRM} (1)	V_{DRM} (1)	V_{RSM} (1)
KP2100/60	5100	5100	6000
KP2100/62	5300	5300	6200
KP2100/65	5600	5600	6500

V_{RRM} = Repetitive peak reverse voltage
 V_{DRM} = Repetitive peak off state voltage
 V_{RSM} = Non repetitive peak reverse voltage (2)

Repetitive peak reverse leakage and off state leakage	I_{RRM}/I_{DRM}	5 mA 250 mA (3)
Critical rate of voltage rise	dv/dt (4)	2000 V/ μ s

Notes:

- (1) All voltage ratings are specified for an applied 50Hz sinusoidal waveform over the temperature range -40 °C to +125 °C.
- (2) 10 msec. max. pulse width
- (3) Maximum value for $T_j = 125$ °C.
- (4) Minimum value for linear and exponential waveshape to 67% rated V_{DRM} . Gate open. $T_j = 125$ °C.
- (5) The value of di/dt is established in accordance with EIA/NIMA Standard JB/T 8950.2-2013

Conducting - On State

Parameter	Symbol	Min.	Max.	Typ.	Units	Conditions
Average value of on-state current	$I_{T(AV)}$		2100		A	Sinewave, 180° conduction, $T_c=70$ °C
RMS value of on-state current	I_{TRMS}		3297		A	Nominal value
Peak one cycle surge (non repetitive) current	I_{TSM}		50000		A	10.0 msec (50Hz), sinusoidal waveshape, 180° conduction, $T_j = 125$ °C
I square t	I^2t		1.25×10^7		A ² s	10 msec
Latching current	I_L		1000		mA	$V_D = 12$ V; $R_L = 12$ ohms
Holding current	I_H		200		mA	$V_D = 12$ V; $I = 2.5$ A
Peak on-state voltage	V_{TM}		2.49		V	$I_{TM}=3000$ A; $T_j = 25$ °C
Threshold voltage, low-level	V_{TO}		1.2		V	$T_j=125$ °C
Slope resistance, low-level	r_T		0.48		m Ω	1000A to 5000A
Critical rate of rise of on-state current(5)	di/dt		200		A/ μ s	$T_j=125$ °C; $V_D = 0.67 V_{DRM}$; $f=50$ Hz; $I_{TM}=3000$ A

Gating

Parameter	Symbol	Min.	Max.	Typ.	Units	Conditions
Peak gate power dissipation	P_{GM}		20		W	
Average gate power dissipation	$P_{G(AV)}$		4		W	
Gate-trigger current	I_{GT}		250		mA	$V_D = 12\text{ V}; R_L = 3\text{ ohms}; T_j = +25\text{ }^\circ\text{C}$
Gate- trigger voltage	V_{GT}	0.7	3.0		V	$V_D = 12\text{ V}; R_L = 3\text{ ohms}; T_j = +25\text{ }^\circ\text{C}$
Peak negative voltage	V_{GRM}		10		V	

Dynamic

Parameter	Symbol	Min.	Max.	Typ.	Units	Conditions
Delay time	t_d			3.0	μs	$I_{TM}=100\text{A}; V_D=67\%V_{DRM}$ Gate pulse: $V_G=30\text{V}; R_G=10\text{ohms};$ $t_r=0.1\mu\text{s}; t_p=20\mu\text{s}$
Turn-off time (with $V_R = -5\text{ V}$)	t_q			700	μs	$I_{TM} = 2000\text{A}; di/dt = -10\text{A}/\mu\text{s};$ $V_R = 100\text{V}; dv/dt = 30\text{V}/\mu\text{s};$ $V_D = 67\%V_{DRM}; T_j = 125^\circ\text{C}$
Reverse recovery charge	Q_{rr}		5000		μC	$I_{TM}=2000\text{A}; di/dt=-10\text{A}/\mu\text{s};$ $V_R=100\text{V}; T_j=125^\circ\text{C}$

THERMAL AND MECHANICAL CHARACTERISTICS AND RATINGS

Parameter	Symbol	Min.	Max.	Typ.	Units	Conditions
Operating temperature	T_j	-40	+125		$^\circ\text{C}$	
Storage temperature	T_{stg}	-40	+140		$^\circ\text{C}$	
Thermal resistance - junction to case	$R_{\Theta(j-c)}$		0.007		$^\circ\text{C}/\text{W}$	Double sided cooled
Thermal resistance - case to heatsink	$R_{\Theta(c-s)}$		0.002		$^\circ\text{C}/\text{W}$	Double sided cooled
Mounting force	F	66	74	70	kN	
Weight	m			1.45	kg	

* Mounting surfaces smooth, flat and greased

